

tapflo®

PERISTALTIC PUMPS

2018 | 1

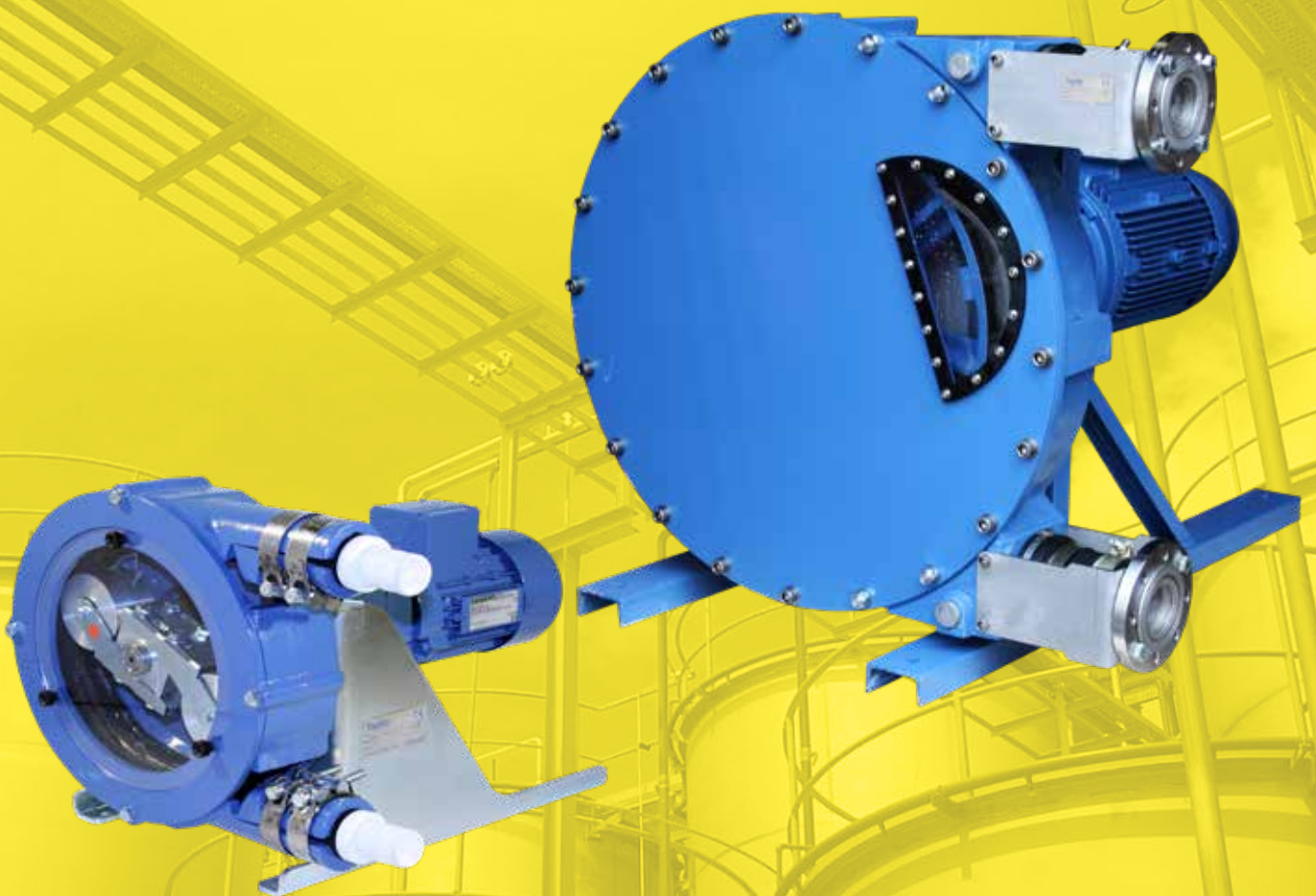

» All about your flow

www.tapflo.com

All about your flow

Tapflo is a leading pump manufacturer with the ambition to provide a wide range of premium products for various industrial applications. We focus on delivering the best fluid processing solutions and support on all stages of the process, worldwide.



About Tapflo

Tapflo is an independent, Swedish, family owned manufacturer and global supplier of air operated diaphragm pumps, centrifugal pumps and other industrial process equipment. The company was founded in Kungälv, Sweden in 1980 and has since then been working with design and manufacture of thermoplastic, metal and sanitary series diaphragm pumps, as well as the complete range of centrifugal pumps and industrial equipment. After years of dynamic development, the company evolved into Tapflo Group with worldwide operations. Tapflo Group is represented by owned companies and independent distributors all over the world on 6 continents.

Quality certified

At Tapflo, we believe that quality is one of the highest values, both for our customers as well as our employees. As a result, we comply with various globally recognised certification and quality control institutions. Many of our products comply with EC ATEX directives for equipment intended for used in explosive and hazardous environments.

The aseptic series is EHEDG certified (European Hygienic Engineering & Design Group) and the pharmaceutical series has USP VI and EC 1935/2004 approval.

All of our products are clearly CE marked and followed by our comprehensive instruction manuals. Tapflo manufacturing process is certified according to ISO 9001:2015.



Our values

■ Long term engagement is our core

Our aim is to continuously provide premium products according to the evolving needs of our customers. That is why we see each customer relationship as a long term commitment.

■ Local means on your terms

Tapflo is your global partner providing local support. No matter where your plant is located, you can expect us to support you locally.

■ Flexibility the foundation of good service

We are prepared to deal with reality, knowing that in practice this means answering questions, offering solutions and supplying spare parts with a minimal loss of time.

■ Customising to bring the product to the needs

Our intention is always to help our clients find the most cost effective solutions to increase their company's efficiency.

If this means changing the design of the pump, we see it as a challenge - not a problem.

■ To produce is to develop

Being actively involved in the manufacturing of a product, it is almost impossible not to discover ways to improve it.

This allows us to frequently offer solutions that are even more sustainable and efficient.

PTL series

Typical applications



Pharmaceutical industry

chemical dosing, liquid protein, vaccines, serum, plasma, syrups



Water treatment

sodium hypochlorite, ferric chloride, sodium bisulfite, fluoride, polymers, aqueous ammonia, potassium permanganate, caustic soda, and many more



Pasta, cheese industry

egg white & yolk, edible fat, semolina, natural flavoring, cream, milk and yogurt

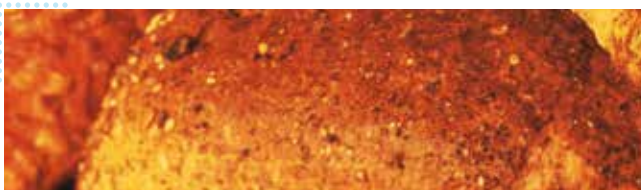

Bread dough & fruit cake

water & salt mixtures, natural flavorings, fats, fruit cake dough/mixture (i.e. fruit cake has nuts and fruit pieces that need to stay whole)



Cosmetics industry

shampoo, liquid soap, shower gel, lotion,

PT series

Typical applications



Industry

various acids, PVDF latex, alcohol, soap, non aromatic solvents, sludge with viscosity up to 60 000 Cps, clay up to 800g/l, particle size: 30 mm, lead sulfate, pyrite, SABX, cyanide, various acids

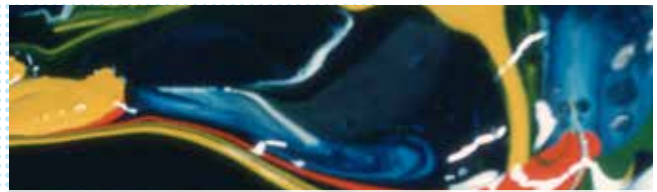

Paint

water based paint, acrylics, pigments, ink, wall coating



Water treatment

lime cream, ferrous chloride, activated carbon, reagent feed, coagulant, flocculate dispersion, alum, sludge and foams



Food industry

tomato sauce, mash potatoes, gelatin, beer yeast, fish paste, olive oil, wine, PAINT water based paint, acrylics, pigments, ink, wall coating



Paper mills

latex, kaolin, paper waste sludge, various chemical dosing

■ Working principle

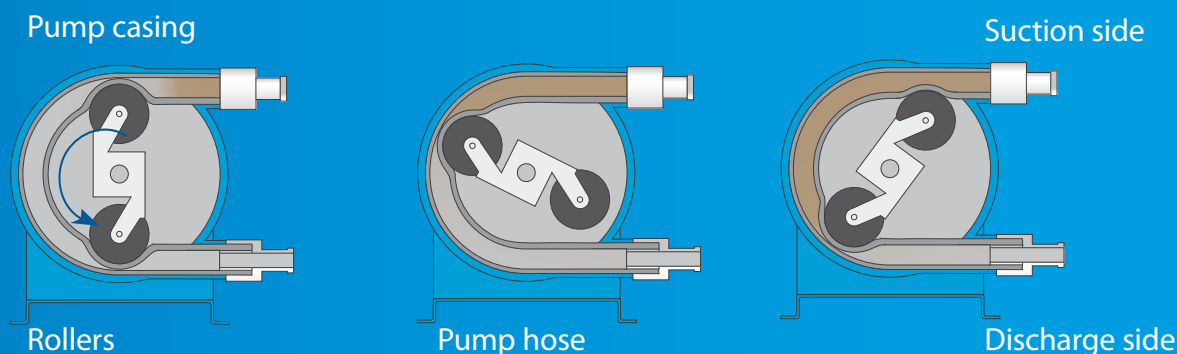

Two rollers* mounted at 180° on a rotor compress alternatively a thick-walled hose in a patented concentric guide and push the pumped liquid from the suction to the discharge side. Roller movement compresses the hose along the casing wall and creates constant vacuum at the suction side of the pump. In this way, liquids are conveyed within the hose and do not get in contact with any metal part.

* PT series is equipped with shoes instead of rollers

Roller design (PTL) vs Shoe Design (PT)

The roller design in PTL pumps has been proven to be successful in the lower pressure applications until 4 bars, since lubrication is not really necessary between hose and roller and the radial force are very low allowing the rotation. To protect the hose, the shoes operate in grease.

For higher pressures until 15 bars, from approximate 4 bar, the rollers do not rotate anymore and the angle at the point of compression becomes fairly steep, which acts negatively on the hose. In this case, the shoe design of PT pumps has been proven to be more efficient, since they act more gentle on the hose.

To protect the hose, the shoes operate in a bath of lubricant. Depending on the application, different oil types or glycerin based can be used.

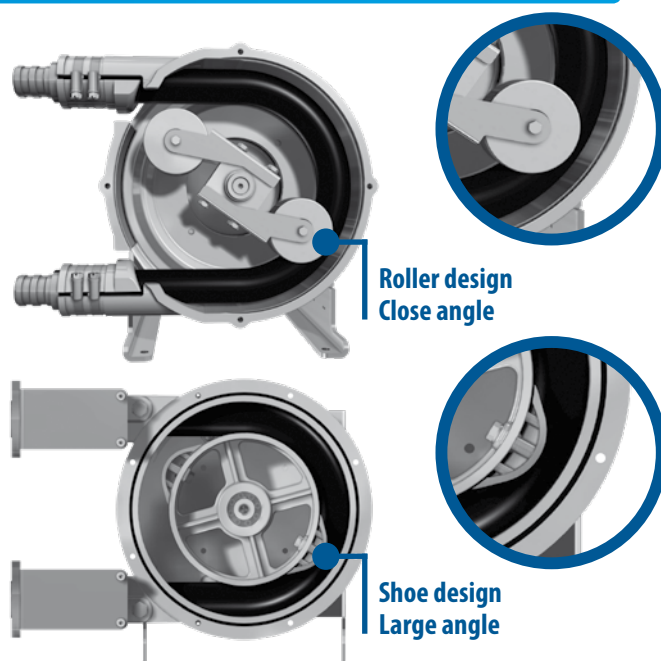

■ Features & Benefits

- ✓ **Seal-less design**
 No mechanical seal or stuffing box and other rotating equipment in media that can cause leakage.
- ✓ **Lowest cost of ownership and quick and easy maintenance**
 Tapflo pumps contain the fluid in a hose, requiring only one component to be changed, which means that maintenance costs are considerably lower than other pump types.
- ✓ **Reversible flow**
 Easy emptying and draining.
- ✓ **Low sound level:**
 Below < 70 dB at 1 meter.
- ✓ **Self-priming and continuous dry running**
 Tapflo pumps can self-prime up to 9.8 metres and run dry indefinitely.
- ✓ **Accurate and repeatable dosing and metering**
 Tapflo pumps are accurate up to $\pm 0.5\%$ across their total speed range, with the additional benefit of process control capabilities which allows easy installation.
- ✓ **Long life and greater reliability**
 The PTL & PT range is designed and manufactured for heavy duty industrial use, and advanced elastomer technology ensuring accurate and repeatable performance that truly outperforms all other pumps.

PTL series

Low pressure hose pumps

Reduce maintenance downtime...

Suitable for pumping and dosing low or high viscous, pasty, pure, neutral, aggressive or abrasive liquids, those containing gases or which tend to froth or those containing solids in the following industries: paint, dairy and beverage, meat and fish processing, pharmaceutical and cosmetics, waste water and water treatment, chemical and petrochemical industries, pulp and paper, textile, soap and fats, building, ceramics.



■ Operating data

Capacity:	up to 10 m ³ /h
Viscosity:	up to 15000 cps ***
Temperature of pumped liquid:	up to 135°C *
Differential pressure:	up to 4 bar **
Discharge pressure:	up to 4 bar
Achievable suction:	up to 0,6 bar ***

* At a room temperature of 20°C. Furthermore, it depends on the pumped fluid, on the hose quality and on the motor construction.

** It depends on the pump dimension and on the hose quality.

*** It depends on the pump dimension/execution, on the speed and on the tube material.

Flow table PTL pumps

[l/h]

TYPE	10 Rpm	20 Rpm	40 Rpm	60 Rpm	80 Rpm	100 Rpm	120 Rpm	140 Rpm
PTL05	2,5	5	10					
PTL09		20	40	60	80			
PTL13		49	98	167	196	245	294	344
PTL17		129	259	389	518	648	778	908

[m³/h]

TYPE	20 Rpm	40 Rpm	60 Rpm	80 Rpm	100 Rpm	120 Rpm	140 Rpm	160 Rpm
PTL25	0,38	0,76	1,15	1,53	1,92	2,30	2,68	3,07
PTL30	0,82	1,64	2,64	3,28	4,10	4,92	5,74	
PTL45	2,30	4,61	6,92	9,23	11,5			



Continuous use

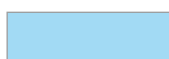

Intermittent use

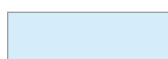

Occasional use
< 1 hour/day

Available drives

Gear motors or variable speed motors, both TEFC and explosion, electronic gear motor, inverters. Upon request, pneumatic drive units are available.

Available hoses materials

Neoprene®, Hypalon, Silicone, NR, EPDM, NBR - foods Pharmed®

Without reinforcing: Neoprene®, Hypalon; Norprene®; Silicone; Pharmed®

With polyamide reinforcing: Natural rubber (NR) ; NBR ; EPDM



® Pharmed Reg. Saint-Gobain Performance Plastics

Mineral	Hose Identification	Operating Temperatures	Industry Approvals	Available
Neoprene	Flat black color, rough surface, rubber smell	0 to 60°C		PTL09 - PTL25
Norprene®	Off white, smooth surface	-35 to 135°C	USP Class VI	PTL09 - PTL45
			FDA 21	
			CFR 177.2600	
			NSF listed (Standard 51)	
Silicone	Transparent, smooth surface	0 to 140°C	USP Class VI	PTL09 - PTL25
			FDA 21	
			CFR 177.2600	
Pharmed®	Cream color, Pharmed* name on hose	-30 to 135°C	USP Class VI	PTL09 - PTL13
			FDA 21	
			CFR 177.2600	
			NSF listed (Standard 51)	
Hypalon	Black color, yellow stripe, double braided	0 to 90°C		PTL09 - PTL45
EPDM Rubber	Black color, white stripe, double braided	0 to 90°C		
Natural Rubber	Black color, green stripe, double braided	0 to 80°C		
Nitrile Rubber	Black color	0 to 80°C		



TAPFLO PTL - Reliable Hose Pumps
 Exceptionally low shear, ensuring product quality,
 accurate and predictable performance
 with subsequent savings.

PT series

High pressure hose pumps

The latest design

PT pumps combine the best available materials with smart design solutions in order to maximise running time and minimise maintenance.

The PT series pump is an extremely reliable pump with a wide performance range, up to 150 m³/h and 15 bars, that can handle most fluids in most applications.



■ Operating data

Capacity:	up to 150 m ³ /h
Viscosity:	up to 100000 cps
Temperature of pumped liquid:	up to 135°C
Discharge pressure:	up to 15 bar
Self priming:	up to 9,8 m

Flow table PT pumps

[l/h]

TYPE	10 Rpm	20 Rpm	40 Rpm	60 Rpm	80 Rpm	100 Rpm	120 Rpm	140 Rpm
PT 05 (3 lobes)	3.4	6.8	13.6	20.4				
PT10 (3 lobes)	10	20	40	60				
PT 10	15	30	60	90	120	150	180	
PT 15	50	100	200	300	400	500	600	
PT 20	65	170	340	500	670	850	970	
PT 25	200	400	800	1 200	1 600	2 000	2 400	2 800

[m³/h]

TYPE	10 Rpm	20 Rpm	40 Rpm	60 Rpm	80 Rpm	100 Rpm	120 Rpm	140 Rpm
PT 32	375	750	1 500	2 250	3 000	3 750	4 500	5 250
PT 40	565	1 170	2 340	3 510	4 680	6 850	7 020	8 190
PTX 40	800	1 600	3 200	4 800	6 400	8 000		
PT 50	1750	3 500	7 000	10 500	14 000	17 500		
PT 65	2300	4 600	9 200	13 800	18 400	23 000		

[m³/h]

TYPE	10 Rpm	20 Rpm	30 Rpm	35 Rpm	40 Rpm	45 Rpm	50 Rpm
PTX 80	5 500	11 000	16 500	19 250	22 000	24 750	27 500
PT 80	7 000	14 000	21 000	24 500	28 000	31 500	35 000
PT 100	12 000	24 000	36 000	42 000	48 000	54 000	
PT 125	22 000	44 000	66 000	77 000	88 000		
PTX 150	50 000	100 000	130 000				

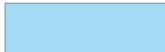
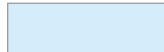
		
Continuous use	Intermittent use	Occasional use < 1 hour/day

Available hoses materials

The PT series is designed to make hose changes quick and easy with no technical knowledge required. We only work with high quality compounded rubbers, reinforced with 2 to 6 individual layers of braided polyamide and with an outer layer made to strict tolerances to ensure perfect compression. The characteristics of Tapflo hoses enable them to last approximately 30% longer than other hoses on the market. They also fit the majority of other hose pumps.

For the hose inner layers, 6 materials are available to suit the diversity of the pumped fluids.

	white marking	double white marking	yellow marking	white & yellow marking	red marking	blue marking	purple marking
	NR (natural rubber)	NR FDA	NBR (buna)	NBR Food (approved FDA)	EPDM	HYPALON/CSM	VITON/FKM
							
Water treatment & Industrial waste	X	X	X		X	X	X
Ceramic industry	X				X		
Mining & quarries	X		X		X	X	X
Building & constructions	X		X		X		
Chemical	X		X		X	X	X
Food & beverage	X	X		X			
Paint	X				X		
Pulp & paper	X				X		
Agriculture, biogas	X	X	X		X	X	X

Pulsation dampener

In-line pulsation dampener will reduce vibration and water hammers in the piping therefore increasing the hose life.

■ Features & Benefits

- Pulsation reduction up to 90%
- Easy installation
- Few parts in contact with media

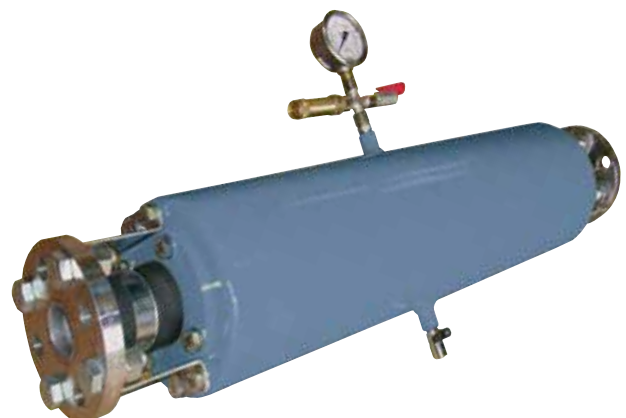

PT series - special versions

High pressure , high capacity

PTX 150

This pump has all the benefits of other peristaltic pumps, with the two key additional benefits of a much slower speed for a given flowrate; and rotating rollers for soft hose compression. These two features greatly increase hose life & reduce power consumption.



Example of applications

- » Effluent Processing
- » Mining Waste / Cake Transfer
- » Mud slurry Transfer
- » Sea Tanker Offloading
- » Sand Slurry Transfer
- » Fish boat doffloading

■ Features & Benefits

- ✓ No mechanical seal or stuffing box
- ✓ Reversible flow
- ✓ Damage-free continuous dry running
- ✓ Without lubricant
- ✓ Suitable for aggressive or viscous fluids
- ✓ Hoses available: NR and full EPDM

PTS series

Bare shaft execution

For customers who require a long shaft technology, Tapflo has also developed the PTS series.

These pumps are equipped with a removable bearing case for easy bearing maintenance and can be converted into a close coupling PT type pump at any time.

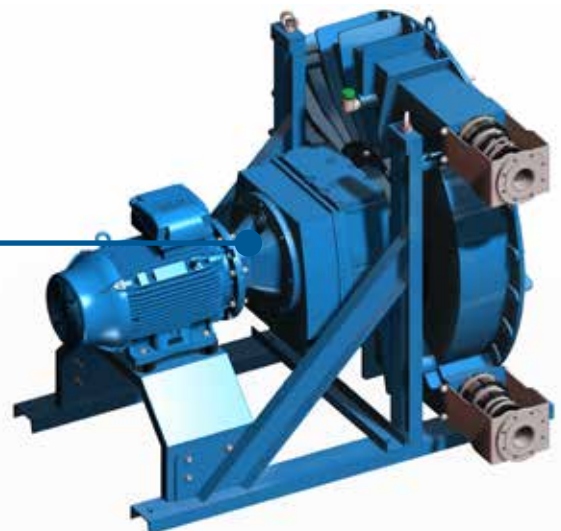

PT CIP

The revolutionary high pressure CLEAN IN PLACE

Tapflo as the leader of innovative peristaltic hose pump has developed a solution for easier and better clean in place hose pumps - A unique wheel to meet the requirements of its industrial customers from food, cosmetic and pharmaceutical industries.

The new PT CIP pump has a patent pending designed pump-wheel that will allow the pressing shoes to retract (not to compress the pump) for an efficient clean in place process.

■ Operating data

Capacity: from 0,5 up to 10 m³/h
Discharge pressure: up to 15 bar



PT pumps are available in "CIP wheel" (Clean In Place) option. It allows users, by simply reversing the direction of rotation of the pump (½ turn), to be able to retract the shoes automatically, in order to make the cleaning and sterilization operations, without any action on the pump. The client saves time and will keep the highest level of functionality in the process.

■ Features & Benefits

- ✓ Seal-less design
- ✓ Can run dry without damage
- ✓ Does not damage or shear the pumped fluid while maintaining a high level of hygiene
- ✓ A maximum amount of function and production time
- ✓ Min. use of moving parts and requires a min. amount of maintenance
- ✓ Only the inner part of the hose is in contact with the pumped fluid

Available hoses materials

Tapflo can offer food grade hoses in **EPDM FDA**, **NBR FDA** and **NR FDA** and meet the certifications EC 1935/2004 and FDA CFR21§177.2600.

The internal of the hose is white (**NR FDA** and **EPDM FDA**) or black (**NBR FDA**), according to the pumped fluid.



Product range

Diaphragm pumps & accessories



PE & PTFE pumps



Metal pumps



Pharmaceutical pumps



Sanitary pumps



TC Intelligent pumps



Powder pumps



TF Filter press pumps



EHEDG aseptic pumps



Active pulsation dampeners



Systems & accessories



Trolleys



Centrifugal pumps, filter units & accessories



CTI & CTH centrifugal pumps



CTP plastic centrifugal pumps



CTM magdrive centrifugal pumps



CTV vertical centrifugal pumps



CTS self-priming centrifugal pumps



Trolleys



FT Filter units

Sweden

Filaregatan 4 | S-442 34 Kungälv

Tel: +46 303 63390

Fax: +46 303 19916

E-mail addresses:

Commercial questions: sales@tapflo.com

Orders: order@tapflo.com

Tech support: support@tapflo.com

Tapflo products and services are available in 75 countries on 6 continents.

Tapflo is represented worldwide by own Tapflo Group Companies and carefully selected distributors assuring highest Tapflo service quality for our customers' convenience.

AUSTRALIA | AUSTRIA | AZERBAIJAN | BAHRAIN | BELARUS | BELGIUM | BOSNIA | BRAZIL | BULGARIA | CANADA | CHILE | CHINA | COLOMBIA | CROATIA | CZECH REPUBLIC | DENMARK | ECUADOR | EGYPT | ESTONIA | FINLAND | FRANCE | GREECE | GEORGIA | GERMANY | HONG-KONG | HUNGARY | ICELAND | INDIA | INDONESIA | IRAN | IRELAND | ISRAEL | ITALY | JAPAN | JORDAN | KAZAKHSTAN | KUWAIT | LATVIA | LIBYA | LITHUANIA | MACEDONIA | MALAYSIA | MEXICO | MONTENEGRO | MOROCCO | THE NETHERLANDS | NEW ZEALAND | NORWAY | POLAND | PORTUGAL | PHILIPPINES | QATAR | ROMANIA | RUSSIA | SAUDI ARABIA | SERBIA | SINGAPORE | SLOVAKIA | SLOVENIA | SOUTH AFRICA | SOUTH KOREA | SPAIN | SUDAN | SWEDEN | SWITZERLAND | SYRIA | TAIWAN | THAILAND | TURKEY | UKRAINE | UNITED ARAB EMIRATES | UNITED KINGDOM | USA | UZBEKISTAN | VIETNAM

Tapflo Group Companies

Austria

Tapflo Austria
Tel: +43 732 27292910
sales@tapflo.at

Azerbaijan

Tapflo Makina Ltd
Tel: +90 216 467 33 11
sales@tapflo.com.tr

Baltic States

Tapflo Latvia
Tel: +371 67472205
sales@tapflo.lv

Belarus

Tapflo Belarus
Tel: +375 17 3934609
sales@tapflo.by

Bulgaria

Tapflo EOOD
Tel: +359 (0)2 974 18 54
office@tapflo.bg

Canada

Tapflo Canada
Tel: +1 514 813 5754
canada@tapflo.com

Croatia

Tapflo GmbH
Tel: +385 91 4884 666
sales@tapflo.hr

Czech Republic

Tapflo s.r.o.
Tel: +420 513 033 924
tapflo@tapflo.cz

China

Tapflo (Wuxi)
Tel: +86 510 8241 7072
sales@tapflo.cn

Denmark

Tapflo Danmark
Tel: +45 36 454600
info@tapflo.dk

France

Tapflo France
Tel: +33 1 34 78 82 40
info@tapflo.fr

Georgia

TOB Tapflo
Tel: +380 44 222 68 44
sales@tapflo.com.ua

India

Tapflo Fluid Handling India Pvt Ltd
Tel: +91 20 65000215
ac@tapflo.in

Ireland

Tapflo Ireland Ltd
Tel: +353 1 2011911
info@tapflo.ie

Italy

Tapflo Italia
Tel: +39 0362307698
info@tapfloitalia.com

Japan

Tapflo Japan K.K.
Tel: +81-3-6240-3510
tapflojp@tapflo.co.jp

Kazakhstan

Tapflo Kazakhstan
Tel: +7 727 3278347
sales@tapflo.kz

Poland

Tapflo Sp. z o.o.
Tel: +48 58 530 42 12
info@tapflo.pl

Romania

S.C. Tapflo Rom. S.r.l.
Tel: +40 21 3451255
sales@tapflo.ro

Russia

Tapflo Company
Tel: +7 495 232 18 28
sales@tapflo.com.ru

Serbia

Tapflo d.o.o.
Tel: +381 21 44 58 08
sales@tapflo.rs

Slovakia

Tapflo s.r.o.
+421 911 137 883
tapflo@tapflo.sk

Slovenia

Tapflo GmbH
Tel: +386 68 613 474
sales@tapflo.hr

Spain

Tapflo Iberica
Tel: +34 91 8093182
avives@tapfloiberica.es

South Africa

Tapflo (Pty) Ltd
Tel: +27 31 701 5255
sales@tapflo.co.za

Turkey

Tapflo Makina Ltd
Tel: +90 216 467 33 11
sales@tapflo.com.tr

Ukraine

TOB Tapflo
Tel: +380 44 222 68 44
sales@tapflo.com.ua

Uzbekistan

Tapflo Uzbekistan
Tel: +998 712370940
sales@tapflo.uz

United Kingdom

Tapflo (UK) Ltd
Tel: +44 2380 252325
sales@tapflo pumps.co.uk